

Computational Geometry

Tutorial #6 — The Art Gallery Problem

Peter Kramer

January 25, 2024

Organisation

Once more — final tutorial!

- The final tutorial will be exclusively for exam prep and your questions
- If you have any topics you would like to repeat, send an email!

Date	Tutorial
16.11.2023	Tutorial #1
23.11.2023	Tutorial #2
07.12.2023	Tutorial #3
21.12.2023	Tutorial #4
11.01.2023	Tutorial #5
25.01.2023	Tutorial #6
08.02.2023	Tutorial #7

The Art Gallery Problem

The Art Gallery Problem

NP-hardness

Example. $F = (x_1 \vee x_2 \vee x_3) \wedge (x_1 \vee x_2 \vee x_3)$

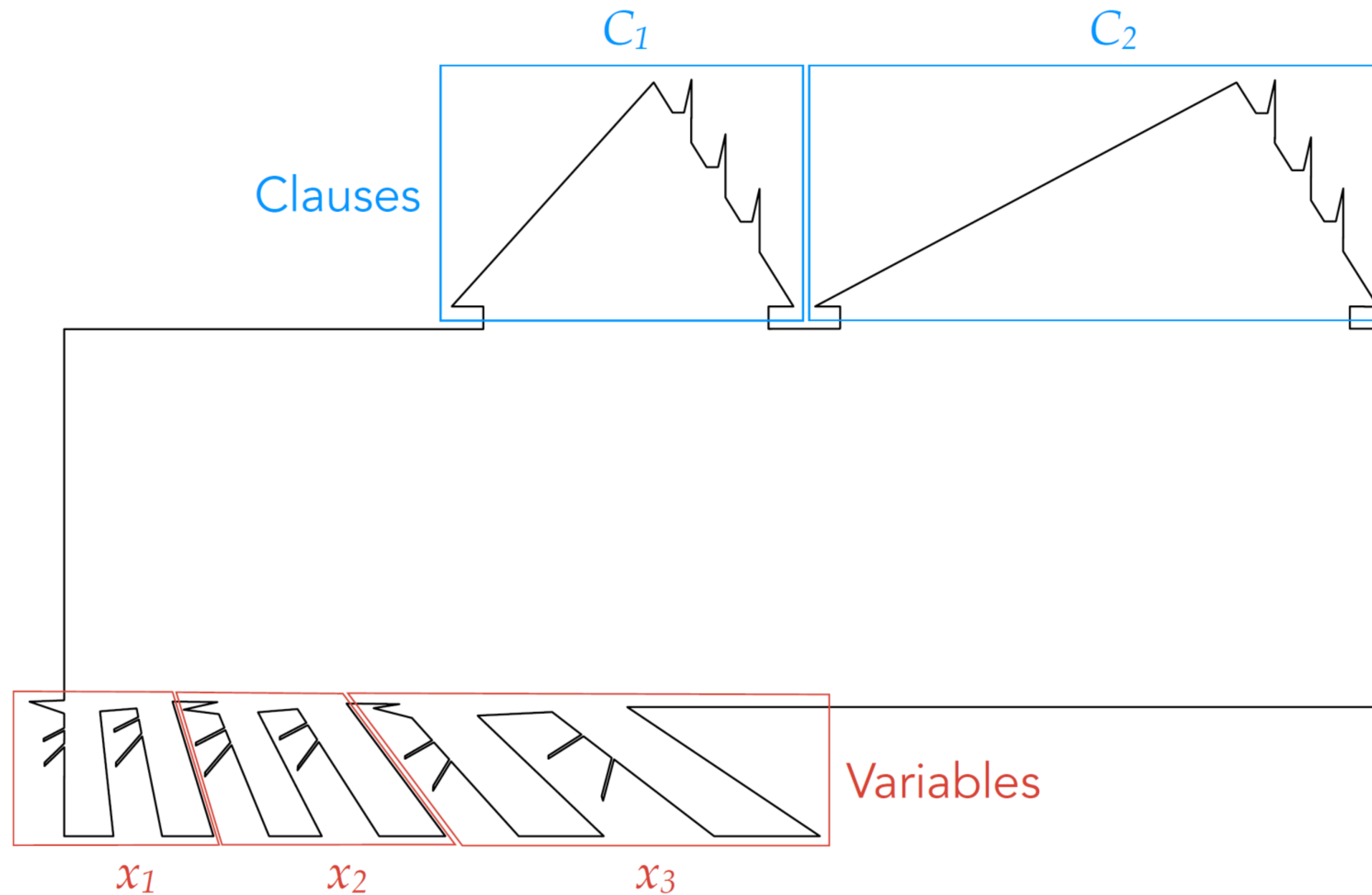

The Art Gallery Problem

NP-hardness

$F = (\bar{x}_1 \vee x_2 \vee \bar{x}_3) \wedge (x_1 \vee x_2 \vee x_3)$
Satisfying interpretation:
 x_1 true, x_2 true, x_3 false

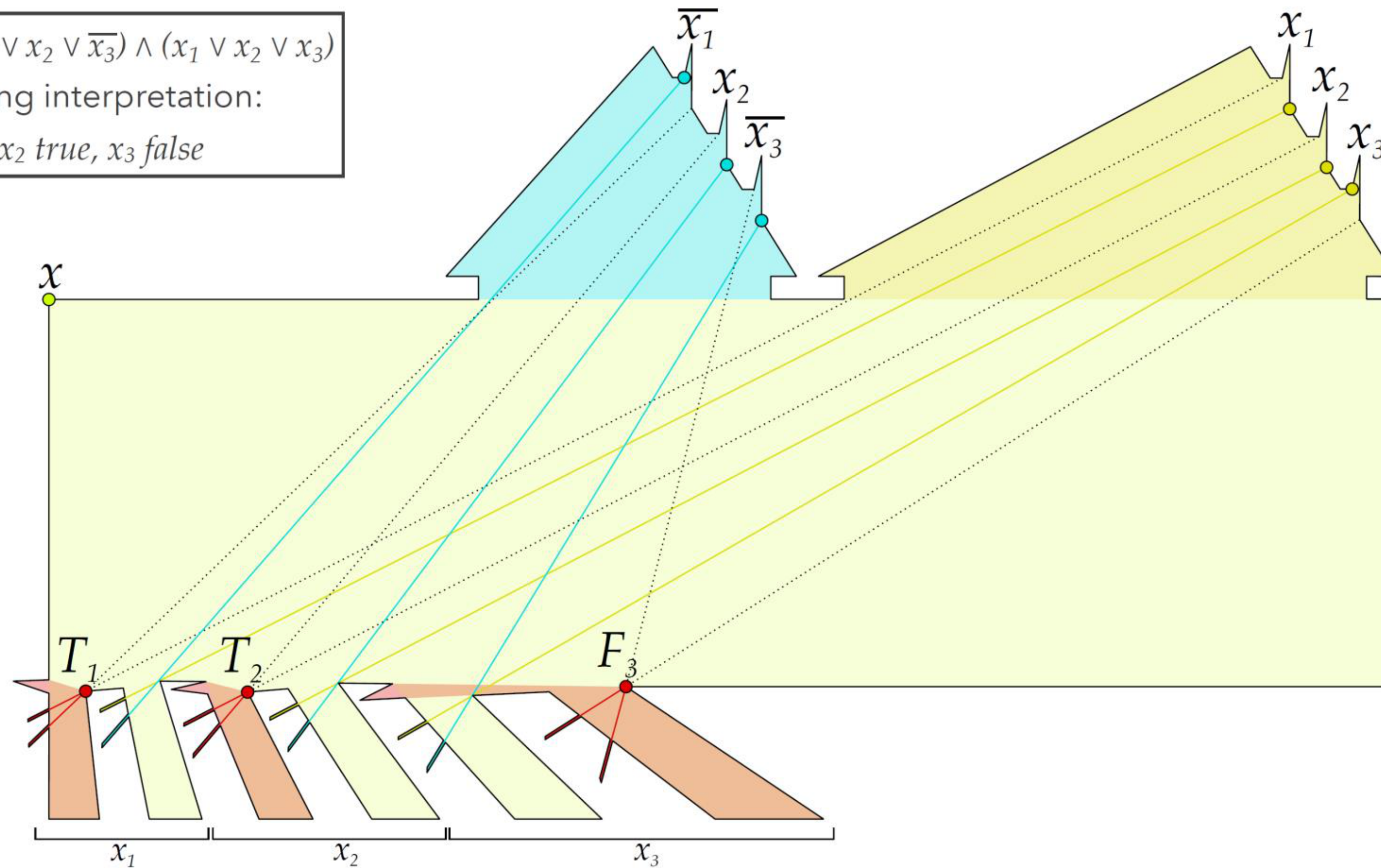

The Art Gallery Problem

Irrational guards

<http://dx.doi.org/10.4230/LIPIcs.SoCG.2017.3>

Indeed, Sándor Fekete posed at MIT in 2010 and at Dagstuhl in 2011 an open problem, asking whether there are polygons requiring irrational coordinates in an optimal guard set [1, 17]. The question has been raised again by Günter Rote at EuroCG 2011 [26]. It has also been mentioned by Rezende *et al.* [13]: “it remains an open question whether there are polygons given by rational coordinates that require optimal guard positions with irrational coordinates”. A similar question has been raised by Friedrichs *et al.* [19]: “[...] it is a long-standing open problem for the more general Art Gallery Problem (AGP): For the AGP it is not known whether the coordinates of an optimal guard cover can be represented with a polynomial number of bits”.

Our results. We answer the open question of Sándor Fekete, by proving the following main result of our paper. Recall that a polygon \mathcal{P} is called *monotone* if there exists a line l such that every line orthogonal to l intersects \mathcal{P} at most twice.

Theorem 1. *There is a simple monotone polygon \mathcal{P} with integer coordinates of the vertices such that*

- (i) \mathcal{P} can be guarded by 3 guards placed at points with irrational coordinates, and
- (ii) an optimal guard set of \mathcal{P} with guards at points with rational coordinates has size 4.

Irrational Guards are Sometimes Needed*

Mikkel Abrahamsen¹, Anna Adamaszek², and Tillmann Miltzow³

1 University of Copenhagen, Copenhagen, Denmark

miab@di.ku.dk

2 University of Copenhagen, Copenhagen, Denmark

anad@di.ku.dk

3 Institute for Computer Science and Control, Hungarian Academy of Sciences (MTA SZTAKI), Budapest, Hungary

t.miltzow@gmail.com

Abstract

In this paper we study the *art gallery problem*, which is one of the fundamental problems in computational geometry. The objective is to place a minimum number of guards inside a simple polygon so that the guards together can see the whole polygon. We say that a guard at position x sees a point y if the line segment xy is contained in the polygon.

Despite an extensive study of the art gallery problem, it remained an open question whether there are polygons given by integer coordinates that require guard positions with irrational coordinates in any optimal solution. We give a positive answer to this question by constructing a *monotone* polygon with integer coordinates that can be guarded by three guards only when we allow to place the guards at points with irrational coordinates. Otherwise, four guards are needed. By extending this example, we show that for every n , there is a polygon which can be guarded by $3n$ guards with irrational coordinates but needs $4n$ guards if the coordinates have to be rational. Subsequently, we show that there are rectilinear polygons given by integer coordinates that require guards with irrational coordinates in any optimal solution.

1998 ACM Subject Classification F.2.2 Nonnumerical Algorithms and Problems

Keywords and phrases art gallery problem, computational geometry, irrational numbers

Digital Object Identifier 10.4230/LIPIcs.SoCG.2017.3

The Art Gallery Problem

Irrational guards

<http://dx.doi.org/10.4230/LIPIcs.SoCG.2017.3>

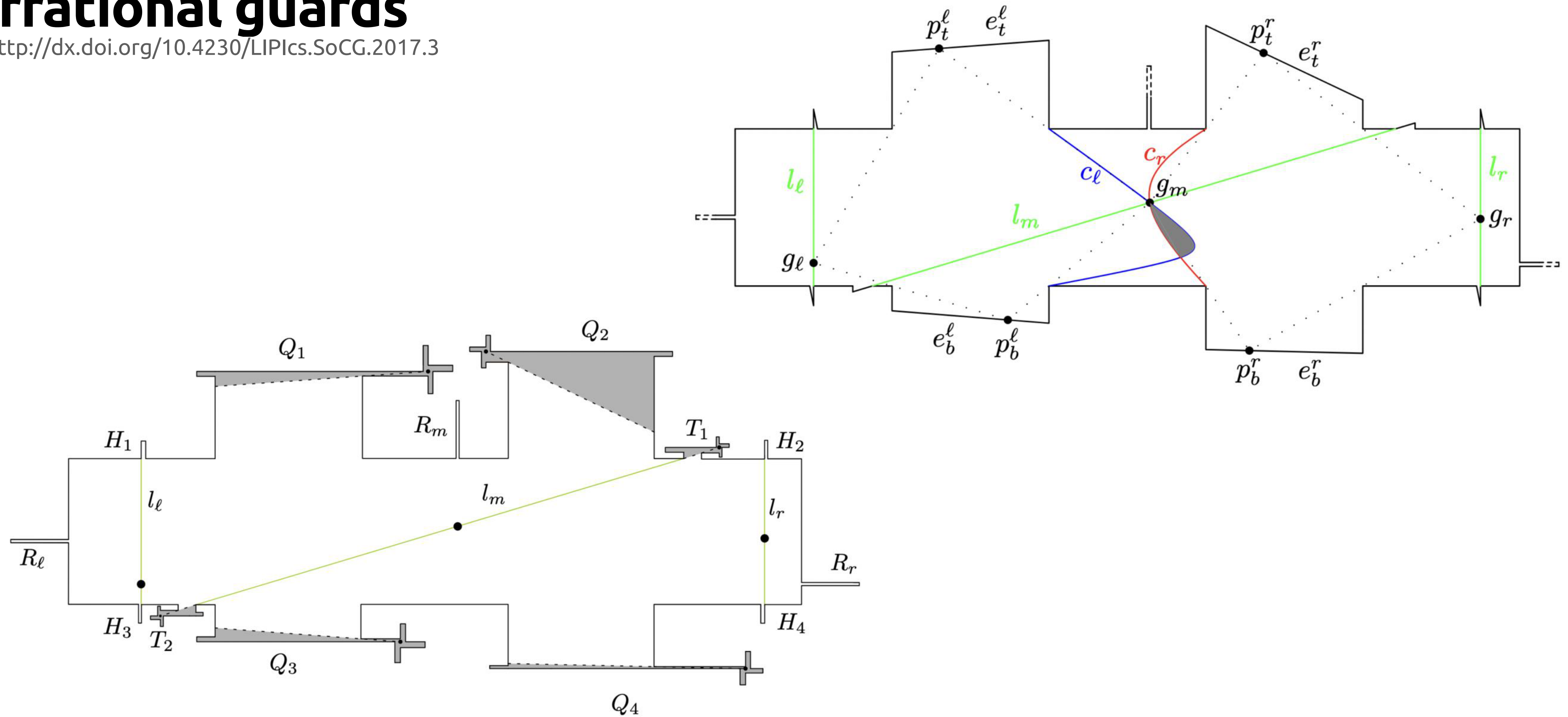

The Art Gallery Problem

$\exists\mathbb{R}$ -completeness

<https://doi.org/10.1145/3486220>

The Art Gallery Problem is $\exists\mathbb{R}$ -complete

MIKKEL ABRAHAMSEN and ANNA ADAMASZEK, University of Copenhagen
TILLMANN MILTZOW, Utrecht University

The *Art Gallery Problem* (AGP) is a classic problem in computational geometry, introduced in 1973 by Victor Klee. Given a simple polygon \mathcal{P} and an integer k , the goal is to decide if there exists a set G of k guards within \mathcal{P} such that every point $p \in \mathcal{P}$ is seen by at least one guard $g \in G$. Each guard corresponds to a point in the polygon \mathcal{P} , and we say that a guard g sees a point p if the line segment pg is contained in \mathcal{P} .

We prove that the AGP is $\exists\mathbb{R}$ -complete, implying that (1) any system of polynomial equations over the real numbers can be encoded as an instance of the AGP, and (2) the AGP is not in the complexity class NP unless $\text{NP} = \exists\mathbb{R}$. As a corollary of our construction, we prove that for any real algebraic number α , there is an instance of the AGP where one of the coordinates of the guards equals α in any guard set of minimum cardinality. That rules out many natural geometric approaches to the problem, as it shows that any approach based on constructing a finite set of candidate points for placing guards has to include points with coordinates being roots of polynomials with arbitrary degree. As an illustration of our techniques, we show that for every compact semi-algebraic set $S \subseteq [0, 1]^2$, there exists a polygon with corners at rational coordinates such that for every $p \in [0, 1]^2$, there is a set of guards of minimum cardinality containing p if and only if $p \in S$.

In the $\exists\mathbb{R}$ -hardness proof for the AGP, we introduce a new $\exists\mathbb{R}$ -complete problem ETR-INV. We believe that this problem is of independent interest, as it has already been used to obtain $\exists\mathbb{R}$ -hardness proofs for other problems.

CCS Concepts: • **Theory of computation** → **Computational geometry**; **Problems, reductions and completeness**; **Complexity classes**;

Additional Key Words and Phrases: Art gallery problem, existential theory of the reals

ACM Reference format:

Mikkel Abrahamsen, Anna Adamaszek, and Tillmann Miltzow. 2021. The Art Gallery Problem is $\exists\mathbb{R}$ -complete. *J. ACM* 69, 1, Article 4 (December 2021), 70 pages.
<https://doi.org/10.1145/3486220>

Other complete problems for the existential theory of the reals include:

- the [art gallery problem](#) of finding the smallest number of points from which all points of a given polygon are visible.^[22]
- the [packing problem](#) of deciding whether a given set of polygons can fit in a given square container.^[23]
- recognition of [unit distance graphs](#), and testing whether the [dimension](#) or Euclidean dimension of a graph is at most a given value.^[9]
- stretchability of pseudolines (that is, given a family of curves in the plane, determining whether they are [homeomorphic](#) to a [line arrangement](#));^{[4][24][25]}
- both weak and strong satisfiability of geometric [quantum logic](#) in any fixed dimension >2 ;^[26]
- Model checking interval Markov chains with respect to unambiguous automata^[27]
- the algorithmic [Steinitz problem](#) (given a [lattice](#), determine whether it is the face lattice of a [convex polytope](#)), even when restricted to 4-dimensional polytopes;^{[28][29]}
- realization spaces of arrangements of certain convex bodies^[30]
- various properties of [Nash equilibria](#) of multi-player games^{[31][32][33]}
- embedding a given abstract complex of triangles and quadrilaterals into three-dimensional Euclidean space;^[17]
- embedding multiple graphs on a shared vertex set into the plane so that all the graphs are drawn without crossings;^[17]
- recognizing the [visibility graphs](#) of planar point sets;^[17]
- (projective or non-trivial affine) satisfiability of an equation between two terms over the [cross product](#);^[34]
- determining the minimum [slope number](#) of a non-crossing drawing of a [planar graph](#);^[35]
- recognizing [graphs that can be drawn with all crossings at right angles](#);^[36]
- the partial evaluation problem for the MATLANG+eigen matrix query language.^[37]
- the low-rank [matrix completion](#) problem.^[38]

The Art Gallery Problem

$\exists\mathbb{R}$ -completeness

<https://doi.org/10.1145/3486220>

The Art Gallery Problem is $\exists\mathbb{R}$ -complete

MIKKEL ABRAHAMSEN and ANNA ADAMASZEK, University of Copenhagen
TILLMANN MILTZOW, Utrecht University

The *Art Gallery Problem* (AGP) is a classic problem in computational geometry, introduced in 1973 by Victor Klee. Given a simple polygon \mathcal{P} and an integer k , the goal is to decide if there exists a set G of k guards within \mathcal{P} such that every point $p \in \mathcal{P}$ is seen by at least one guard $g \in G$. Each guard corresponds to a point in the polygon \mathcal{P} , and we say that a guard g sees a point p if the line segment pg is contained in \mathcal{P} .

We prove that the AGP is $\exists\mathbb{R}$ -complete, implying that (1) any system of polynomial equations over the real numbers can be encoded as an instance of the AGP, and (2) the AGP is not in the complexity class NP unless $\text{NP} = \exists\mathbb{R}$. As a corollary of our construction, we prove that for any real algebraic number α , there is an instance of the AGP where one of the coordinates of the guards equals α in any guard set of minimum cardinality. That rules out many natural geometric approaches to the problem, as it shows that any approach based on constructing a finite set of candidate points for placing guards has to include points with coordinates being roots of polynomials with arbitrary degree. As an illustration of our techniques, we show that for every compact semi-algebraic set $S \subseteq [0, 1]^2$, there exists a polygon with corners at rational coordinates such that for every $p \in [0, 1]^2$, there is a set of guards of minimum cardinality containing p if and only if $p \in S$.

In the $\exists\mathbb{R}$ -hardness proof for the AGP, we introduce a new $\exists\mathbb{R}$ -complete problem ETR-INV. We believe that this problem is of independent interest, as it has already been used to obtain $\exists\mathbb{R}$ -hardness proofs for other problems.

CCS Concepts: • **Theory of computation** → **Computational geometry**; **Problems, reductions and completeness**; **Complexity classes**;

Additional Key Words and Phrases: Art gallery problem, existential theory of the reals

ACM Reference format:

Mikkel Abrahamsen, Anna Adamaszek, and Tillmann Miltzow. 2021. The Art Gallery Problem is $\exists\mathbb{R}$ -complete. *J. ACM* 69, 1, Article 4 (December 2021), 70 pages. <https://doi.org/10.1145/3486220>

4



- [Main page](#)
- [Recent changes](#)
- [Random page](#)
- [Help about MediaWiki](#)

Tools

- [What links here](#)
- [Related changes](#)
- [Special pages](#)
- [Printable version](#)
- [Permanent link](#)
- [Page information](#)

[Create account](#) [Log in](#)

[Main page](#)

[Discussion](#)

[Read](#)

[More](#) ▾

[Q](#)

Complexity Zoo

Introduction

Welcome to the **Complexity Zoo**... There are now 547 classes and counting!

Complexity classes by letter:

[Symbols](#) - [A](#) - [B](#) - [C](#) - [D](#) - [E](#) - [F](#) - [G](#) -
[H](#) - [I](#) - [J](#) - [K](#) - [L](#) - [M](#) - [N](#) - [O](#) - [P](#) - [Q](#) -
[R](#) - [S](#) - [T](#) - [U](#) - [V](#) - [W](#) - [X](#) - [Y](#) - [Z](#)

Lists of related classes:

[Communication Complexity](#) -
[Hierarchies](#) - [Nonuniform](#)

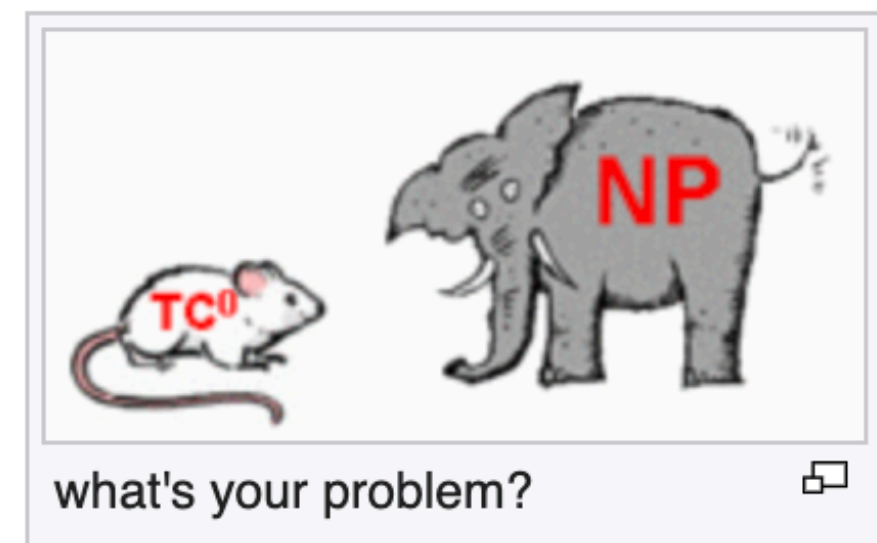

More Guarding Problems

The Art Gallery Problem

Dispersed guards

<https://doi.org/10.4230/LIPIcs.ISAAC.2022.67>

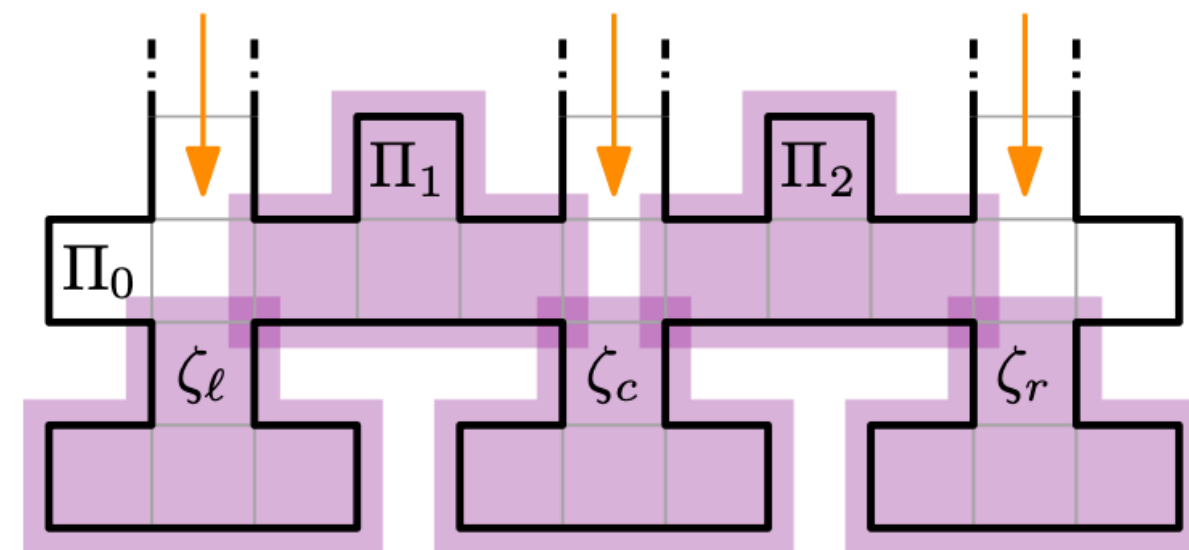
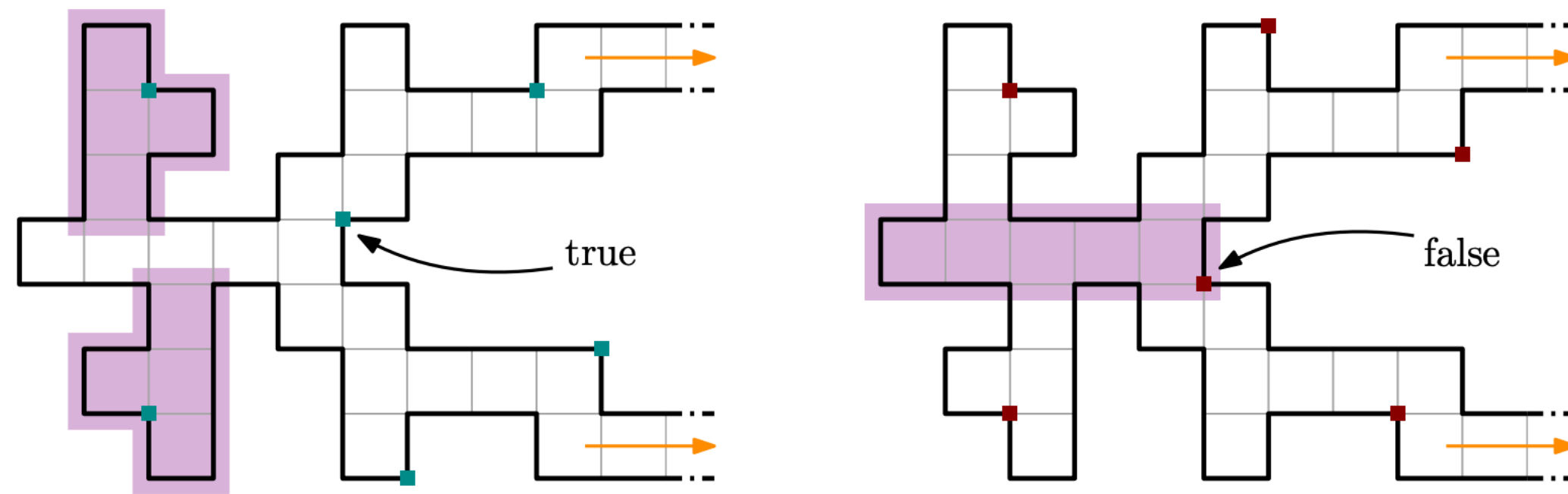

NP-hard to find guard set for distance 5

distance 3 is always possible

The Dispersive Art Gallery Problem

Christian Rieck 

Department of Computer Science, TU Braunschweig, Germany

Christian Scheffer 

Faculty of Electrical Engineering and Computer Science, Bochum University of Applied Sciences, Germany

Abstract

We introduce a new variant of the art gallery problem that comes from safety issues. In this variant we are not interested in guard sets of smallest cardinality, but in guard sets with largest possible distances between these guards. To the best of our knowledge, this variant has not been considered before. We call it the **DISPERSIVE ART GALLERY PROBLEM**. In particular, in the dispersive art gallery problem we are given a polygon \mathcal{P} and a real number ℓ , and want to decide whether \mathcal{P} has a guard set such that every pair of guards in this set is at least a distance of ℓ apart.

In this paper, we study the vertex guard variant of this problem for the class of polyominoes. We consider rectangular visibility and distances as geodesics in the L_1 -metric. Our results are as follows. We give a (simple) thin polyomino such that every guard set has minimum pairwise distances of at most 3. On the positive side, we describe an algorithm that computes guard sets for simple polyominoes that match this upper bound, i.e., the algorithm constructs worst-case optimal solutions. We also study the computational complexity of computing guard sets that maximize the smallest distance between all pairs of guards within the guard sets. We prove that deciding whether there exists a guard set realizing a minimum pairwise distance for all pairs of guards of at least 5 in a given polyomino is **NP-complete**.

The Art Gallery Problem

Chromatic guards

<https://cccg.ca/proceedings/2014/papers/paper11.pdf>

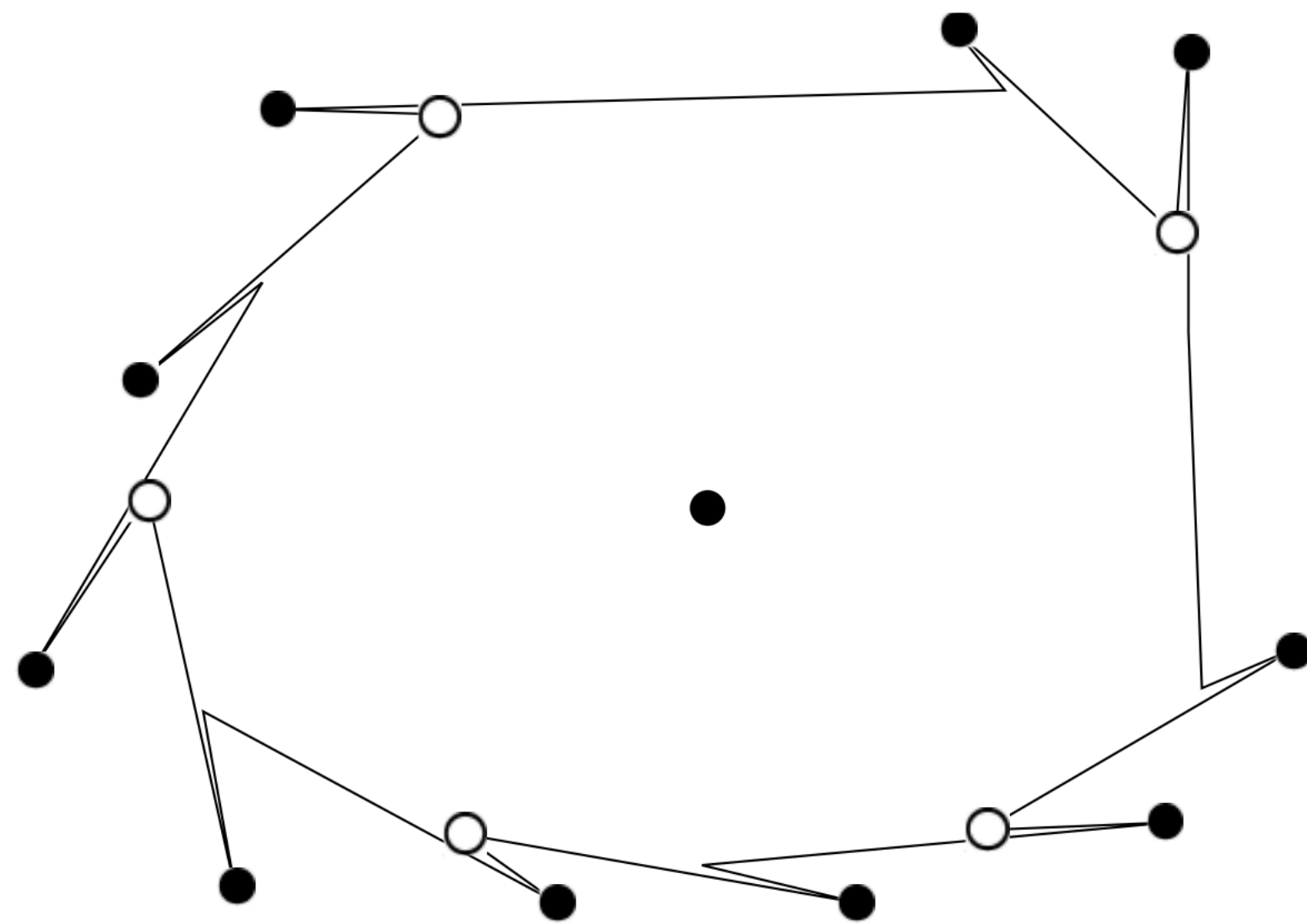

CCCG 2014, Halifax, Nova Scotia, August 11–13, 2014

On the Chromatic Art Gallery Problem

Sándor P. Fekete* Stephan Friedrichs* Michael Hemmer* Joseph B. M. Mitchell†
Christiane Schmidt*

Abstract

For a polygonal region P with n vertices, a *guard cover* S is a set of points in P , such that any point in P can be seen from a point in S . In a *colored guard cover*, every element in a guard cover is assigned a color, such that no two guards with the same color have overlapping visibility regions. The Chromatic Art Gallery Problem (CAGP) asks for the minimum number of colors for which a colored guard cover exists.

We discuss the CAGP for the case of only two colors. We show that it is already *NP*-hard to decide whether two colors suffice for covering a polygon with holes, even when arbitrary guard positions are allowed. For simple polygons with a discrete set of possible guard locations, we give a polynomial-time algorithm for deciding whether a two-colorable guard set exists. This algorithm can be extended to optimize various additional objective functions for two-colorable guard sets, in particular minimizing the guard number, minimizing the maximum area of a visibility region, and minimizing or maximizing the overlap between visibility regions. We also show results for a larger number of colors: computing the minimum number of colors in simple polygons with arbitrary guard positions is *NP*-hard for $\Theta(n)$ colors, but allows an $O(\log(OPT))$ approximation for the number of colors.

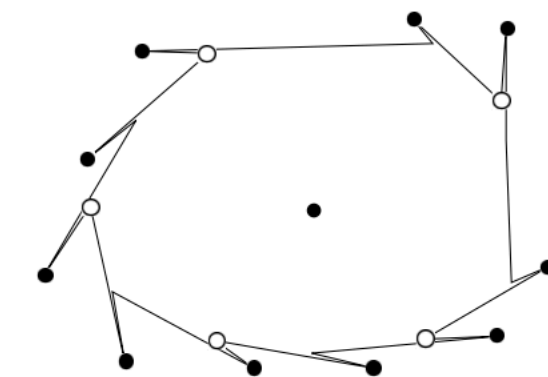

Figure 1: An example polygon with $n = 20$ vertices. A minimum-cardinality guard cover with $n/4$ guards (shown in white) requires $n/4$ colors, while a minimum-color guard cover (shown in black) has $n/2 + 1$ guards and requires only 3 colors.

ART GALLERY PROBLEM (AGP). However, the number of guards and their positions for optimal AGP and CAGP solutions can be quite different, even in cases as simple as the one shown in Figure 1.

Related Work. The closely related AGP is *NP*-hard [13], even for simple polygons. See [15, 16, 18] for three surveys with a wide variety of results. More recently, there has been work on developing practical optimization methods for computing optimal AGP solutions [12, 17, 10, 5].

The Art Gallery Problem

Conflict-free chromatic guards

<https://doi.org/10.1016/j.comgeo.2018.01.003>

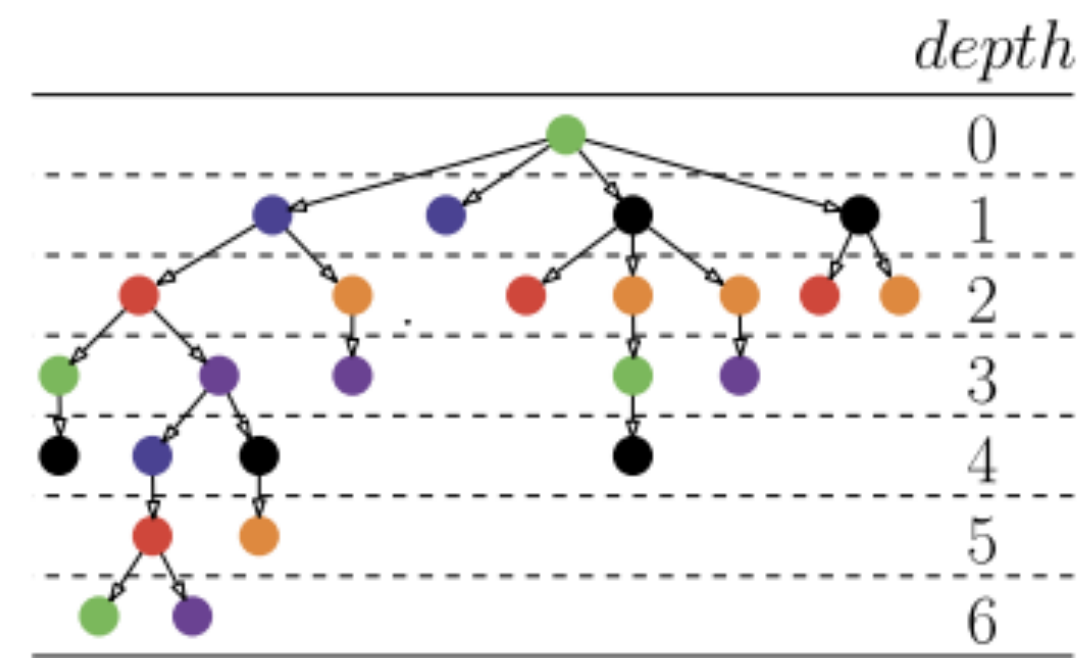
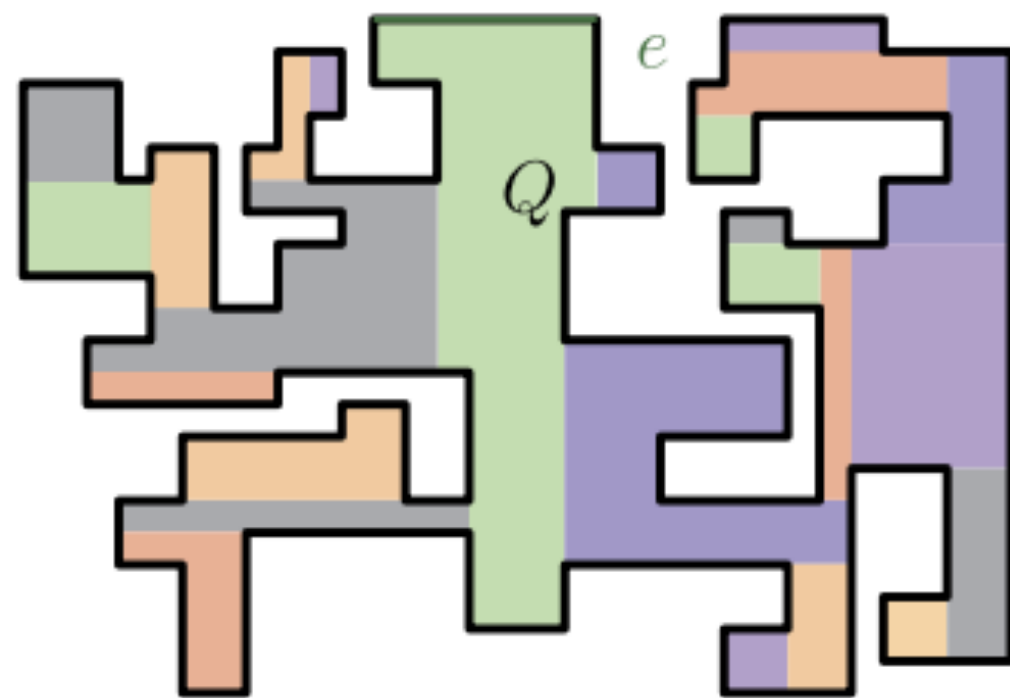

Computational Geometry 73 (2018) 24–34



Contents lists available at ScienceDirect

Computational Geometry: Theory and Applications

www.elsevier.com/locate/comgeo

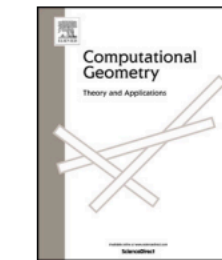

Tight bounds for conflict-free chromatic guarding of orthogonal art galleries

Frank Hoffmann^a, Klaus Kriegel^a, Subhash Suri^c, Kevin Verbeek^{b,*}, Max Willert^a

^a Freie Universität Berlin, Institut für Informatik, 14195 Berlin, Germany

^b Department of Mathematics and Computer Science, Eindhoven University of Technology, Eindhoven, The Netherlands

^c Department of Computer Science, University of California Santa Barbara, Santa Barbara, USA

ARTICLE INFO

Article history:

Received 6 July 2015

Received in revised form 22 November 2016

Accepted 5 January 2018

Available online 12 January 2018

Keywords:

Orthogonal polygons

Art gallery problem

Hypergraph coloring

ABSTRACT

The chromatic art gallery problem asks for the minimum number of “colors” t so that a collection of point guards, each assigned one of the t colors, can see the entire polygon subject to some conditions on the colors visible to each point. In this paper, we explore this problem for orthogonal polygons using *orthogonal visibility*—two points p and q are mutually visible if the smallest axis-aligned rectangle containing them lies within the polygon. Our main result establishes that for a *conflict-free* guarding of an orthogonal n -gon, in which at least one of the colors seen by every point is unique, the number of colors is in the worst case $\Theta(\log \log n)$. By contrast, the best known upper bound for orthogonal polygons under standard (non-orthogonal) visibility is $O(\log n)$ colors. We also show that the number of colors needed for *strong* guarding of simple orthogonal polygons, where all the colors visible to a point are unique, is, again in the worst case, $\Theta(\log n)$. Finally, our techniques also help us establish the first non-trivial lower bound of $\Omega(\log \log n / \log \log \log n)$ for conflict-free guarding under standard visibility. To this end we introduce and utilize a novel discrete combinatorial structure called *multicolor tableau*.

© 2018 Elsevier B.V. All rights reserved.

The Art Gallery Problem

Floodlight Problem

<https://doi.org/10.1142/S0218195997000090>

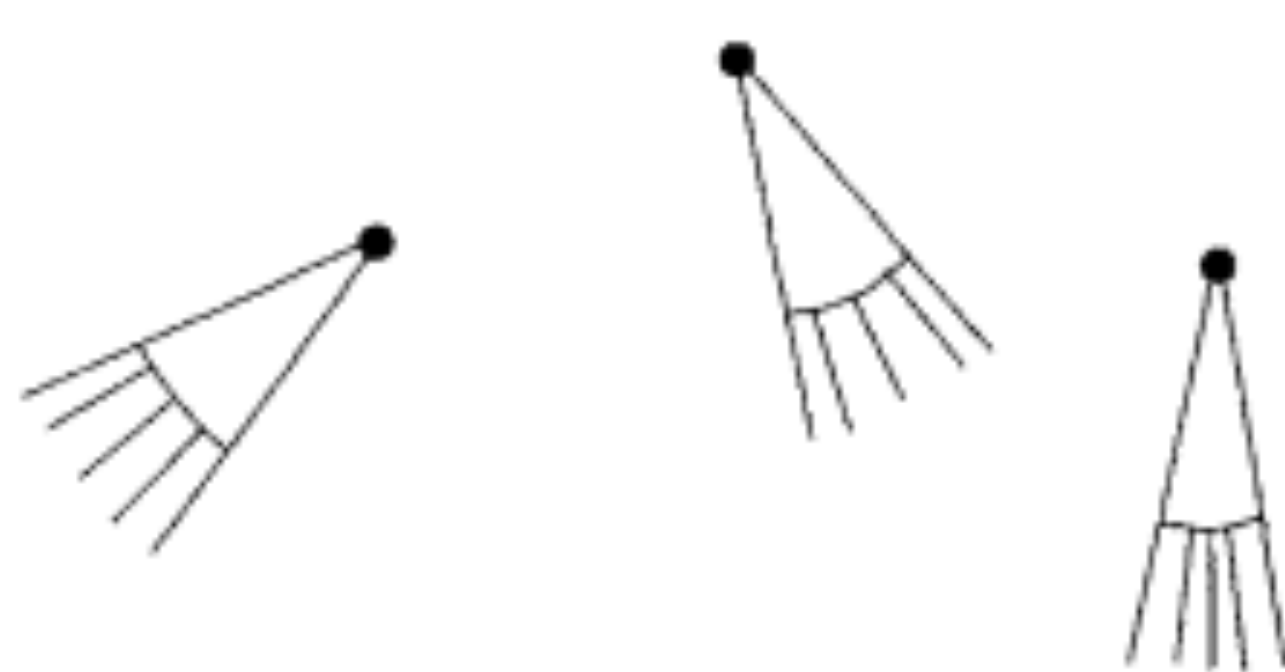

THE FLOODLIGHT PROBLEM*

Prosenjit Bose¹ Leonidas Guibas² Anna Lubiw³
Mark Overmars⁴ Diane Souvaine⁵ Jorge Urrutia⁶

Abstract

Given three angles summing to 2π , given n points in the plane and a tripartition $k_1 + k_2 + k_3 = n$, we can tripartition the plane into three wedges of the given angles so that the i -th wedge contains k_i of the points. This new result on dissecting point sets is used to prove that lights of specified angles not exceeding π can be placed at n fixed points in the plane to illuminate the entire plane if and only if the angles sum to at least 2π . We give $O(n \log n)$ algorithms for both these problems.

1. Introduction

Illumination problems have been a source of many interesting results in computational geometry, for example in the area of Art Gallery theorems and algorithms—see [O'R], [S]. The usual scenario is that we have some target objects in two or more dimensions that are to be illuminated, and some specified sites for lights, which are assumed to shine light in every direction—i.e. with an angle of illumination of 360° in the planar case. See [CRU] and [CRCU] for some recent results of this nature.

In this paper we will consider a variant of these problems in which lights are constrained to shine in some specified angles of illumination: Given n points in the plane which are to be the positions of n floodlights, and given n planar angles representing the arcs of illumination of the floodlights, decide how to assign the floodlights to the points and how to fix their rotational angles, in order to light up some target. A harder problem is to minimize the number of floodlights needed. We will consider two types of target: a line segment (or “stage”), and the whole plane.

At a recent workshop, Jorge Urrutia posed the version of this problem for lighting up a stage. This “Stage Light” problem seems difficult. In section 3 we give a counterexample to an intuitively plausible greedy algorithm.

The Art Gallery Problem

Terrain / Altitude guarding

<https://doi.org/10.1016/j.comgeo.2019.07.004>

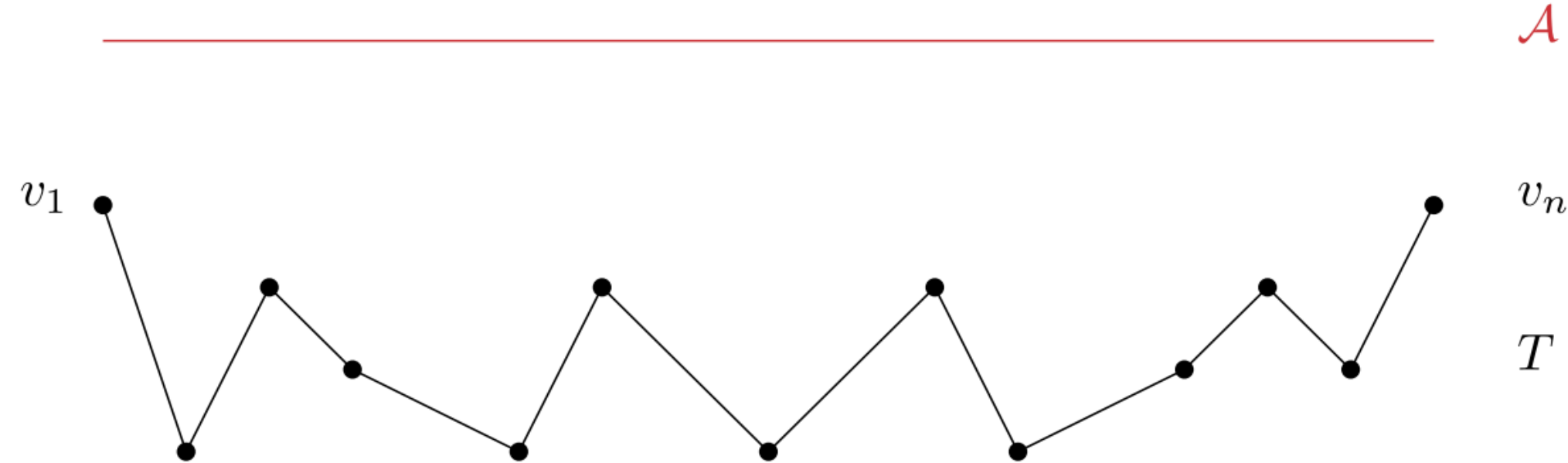

Computational Geometry 84 (2019) 22–35



ELSEVIER

Contents lists available at ScienceDirect

Computational Geometry: Theory and Applications

www.elsevier.com/locate/comgeo



Altitude terrain guarding and guarding uni-monotone polygons



Ovidiu Daescu^a, Stephan Friedrichs^{b,c}, Hemant Malik^a, Valentin Polishchuk^d,
Christiane Schmidt^{d,*}

^a Department of Computer Science, University of Texas at Dallas, United States of America

^b Max Planck Institute for Informatics, Saarbrücken, Germany

^c Saarbrücken Graduate School of Computer Science, Saarbrücken, Germany

^d Communications and Transport Systems, ITN, Linköping University, Norrköping, Sweden

ARTICLE INFO

Article history:

Received 25 May 2018

Received in revised form 19 December 2018

Accepted 1 March 2019

Available online 29 July 2019

Keywords:

Terrain guarding problem
Altitude terrain guarding problem
Perfect polygons
Uni-monotone polygons
Monotone mountains

ABSTRACT

We present an optimal, linear-time algorithm for the following version of terrain guarding: given a 1.5D terrain and a horizontal line, place the minimum number of guards on the line to see all of the terrain. We prove that the cardinality of the minimum guard set coincides with the cardinality of a maximum number of “witnesses”, i.e., terrain points, no two of which can be seen by a single guard. We show that our results also apply to the Art Gallery problem in “monotone mountains”, i.e., x -monotone polygons with a single edge as one of the boundary chains. This means that any monotone mountain is “perfect” (its guarding number is the same as its witness number); we thus establish the first non-trivial class of perfect polygons.

© 2019 Elsevier B.V. All rights reserved.